

TOTEM

FOYERS DE CHEMINÉE | FIREPLACES

LA VISION INTÉGRALE DU FEU
A TOTAL VIEW OF FIRE





sommaire

gamme **technika**

frontal	p.6
latéral	p.8
3 faces	p.10
épi	p.12
4 faces suspendu	p.14

gamme **classic**

foyers droits straight fireplaces	p.19
foyers multifaces multisided fireplaces	p.27
foyers galbés curved fireplaces	p.33
foyers recto-verso séparatifs separating double sided fireplaces	p.39
foyers recto-verso centraux central double sided fireplaces	p.43
foyers suspendus suspended fireplaces	p.47

accessoires | *accessories*

système de suspension suspension system	p.52
les cadres de finition frames	p.54
Porte-bûche Log stand	p.58
système d'accrochage mural wall hanging system	p.59

caractéristiques techniques | *technical features*

synoptique de la gamme totem	p. 60
synoptic of the totem range	
schéma dynamique dynamic drawing	p.64

LE SAVOIR-FAIRE FRANÇAIS
AU SERVICE DE VOTRE PROJET



MADE IN FRANCE
MADE IN DRÔME
MADE IN VALENCE



AVANT-PROPOS | FOREWORD

LA VISION INTÉGRALE DU FEU

Entreprise à taille humaine, TOTEM se consacre exclusivement à la conception et la fabrication de foyers de cheminées de hautes qualités et performances.

Depuis plus de vingt ans, la technologie de pointe et le savoir-faire artisanal made in France sont les garants de la qualité et de la fiabilité qui caractérisent chaque foyer produit par l'entreprise drômoise.

Les foyers de cheminée TOTEM se distinguent particulièrement par leurs portes - comportant 1 à 4 faces - qui s'escamotent totalement dans la hotte pour offrir une vision intégrale du feu.

Telle est la signature des foyers TOTEM, qui fonctionnent porte ouverte comme porte fermée, conciliant le charme d'une cheminée traditionnelle et la performance énergétique d'un foyer fermé.

Pièce unique créée à votre intention, votre foyer TOTEM constituera le cœur de votre future cheminée.



A TOTAL VIEW OF FIRE

A company on human scale, TOTEM is entirely dedicated to create and to manufacture high end fireplaces of high performance.

For more than twenty years, the advanced technology and the handmade knowhow Made in France are the guarantee of the quality and the reliability that characterise each fireplace produced by the company located in the South East of France.

TOTEM fireplaces can be distinguished thanks to their doors - of 1 to 4 sided - that are totally retractable into the hood so as to provide a total view of fire.

This is the hallmark of TOTEM which fireplaces can be used as door open as door closed, bringing at the same time the charming atmosphere of an open and traditional fireplace and the energy performance of a closed fireplace

A unique appliance made especially for you, the TOTEM fireplace will be the heart of your home.

LA HAUTE PERFORMANCE ÉNERGÉTIQUE

TOTEM a fait de la qualité de ses foyers de cheminée sa marque de fabrique, comme en témoigne sa gamme historique Classic, idéale pour la rénovation.

Optimisant jour après jour l'efficacité énergétique de ses foyers, TOTEM se positionne résolument sur le segment du haut de gamme européen en matière de foyers de cheminée classifiés étanches.

Sa gamme Technika en est la meilleure expression. Étanches à l'air de l'habitat et de haute qualité de combustion, les foyers de cheminée Technika allient en effet rendement énergétique élevé et émissions réduites. Une performance qui tend à devenir la référence maison des foyers TOTEM pour relever le défi de la transition énergétique.

En constant essor, avec la multiplication des modèles proposés, la gamme Technika répond en toutes circonstances à l'évolution de la réglementation française (RT 2012) et européenne (Eco Design).

De la rénovation à la construction de maison labellisée BBC ou RT 2012, les foyers de cheminée TOTEM s'intègrent parfaitement à tous les types d'habitat. Vous trouverez le vôtre parmi les 50 modèles aujourd'hui à votre disposition.

THE HIGH ENERGY EFFICIENCY

TOTEM fireplaces quality is its identifying mark that is underlined by the historical range named Classic, perfect for renovation.

Improving day after day the energy performance of its fireplaces, TOTEM belongs to the high end European segment based on air-tight fireplaces.

Its Technika range is its best proof. Air tight to the ambient air of the house, high quality of combustion, Technika fireplaces combine high energy efficiency and reduced emissions. This efficiency trends to become the main benchmark for TOTEM fireplaces to challenge the energy transition.

In constant rise, many Technika models are created so as to comply with each upgrade and change of the French (RT 2012) or European (Eco Design) standards.

From renovation to new construction BBC or RT 2012 certifications, TOTEM fireplaces fit perfectly to all housings. You will definitely find the one made for you among the 49 models available.



vous et votre foyer
pour des feux éco-responsables
*You and your fireplace
for Eco-friendly fires*

gamme **technika**

Grâce à leur **système d'air indépendant** et leur **qualité d'étanchéité** les foyers Technika sont utilisables dans toutes les situations y compris dans les maisons labélisées BBC* ou RT 2012.

Pour garantir un fonctionnement totalement indépendant de l'environnement dans lequel ils sont installés, les foyers Technika ont été dotés des dernières innovations Totem en matière d'étanchéité (l'ensemble des joints ayant été repensé). Ceci permet d'obtenir une **combustion de très grande qualité** et des **performances remarquables** (quantité de bois brûlé/chaaleur obtenue).



** Batiment Basse Consommation*



Because of their independent air system and excellent sealing properties the Technika fireplaces can be used in all situations including in houses approved "Buildings with reduced consumption" and RT 2012 (Thermal Regulations 2012).

To guarantee a smooth running totally independent of the environment in which they are installed, Technika fireplaces benefit from Totem's latest innovations in terms of sealing. (All gaskets have been re-designed). All this allows obtaining high quality combustion and remarkable performances. (quantity of wood burned / heat obtained)

** Buildings with reduced energy consumption*

frontal



	dimensions hors tout : hauteur x largeur x profondeur overall dimensions in mm: width x height x depth	âtre : largeur x profondeur hearth: width x depth	hauteur de vision de feu Fire viewing height	Ø sortie de fumées Ø Smoke vent
frontal 800 technika	1635 x 1008 x 488	704 x 296	505	180F
new frontal 900 * technika	1745 x 1118 x 488	814 x 296	560	200F
new frontal 1000 * technika	1745 x 1228 x 488	924 x 296	560	200F

* Disponible juin 2019 / Available June 2019

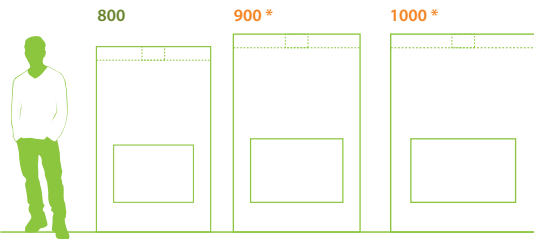

horizon



	dimensions hors tout : hauteur x largeur x profondeur overall dimensions in mm: width x height x depth	âtre : largeur x profondeur hearth: width x depth	hauteur de vision de feu Fire viewing height	Ø sortie de fumées Ø Smoke vent
horizon 800 technika	1525 x 1008 x 488	704 x 296	450	180F
new horizon 900 * technika	1635 x 1118 x 488	814 x 296	505	200F
new horizon 1000 * technika	1635 x 1228 x 488	924 x 296	505	200F

* Disponible juin 2019 / Available June 2019

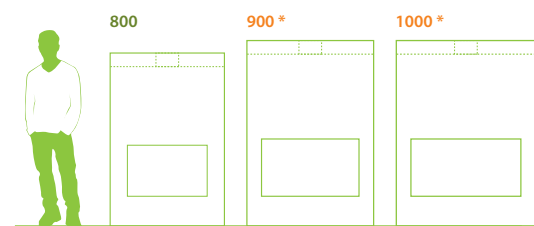



latéral



	dimensions hors tout : hauteur x largeur x profondeur overall dimensions in mm: width x height x depth	âtre : largeur x profondeur hearth: width x depth	hauteur de vision de feu Fire viewing height	Ø sortie de fumées Ø Smoke vent
latéral 800 technika	1569 x 900 x 676	607 x 347	530	200F
new latéral 900 technika	1462 x 1010 x 606	712 x 277	475	200F
new latéral 1000 technika	1569 x 1120 x 607	827 x 277	530	200F

Retrouvez toutes les caractéristiques techniques page 60
Find all technical features page 60

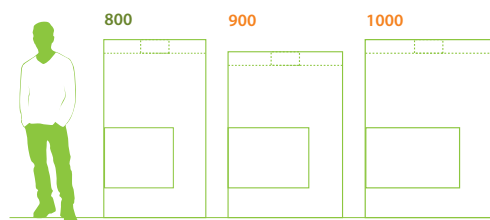



3 faces



	dimensions hors tout : hauteur x largeur x profondeur overall dimensions in mm: width x height x depth	âtre : largeur x profondeur hearth: width x depth	hauteur de vision de feu Fire viewing height	Ø sortie de fumées Ø Smoke vent
3 faces 800 technika	1569 x 900 x 676	646 x 347	530	250F
new 3 faces 900 technika	1459 x 1010 x 606	756 x 277	476	250F
new 3 faces 1000 technika	1569 X 1120 X 606	866 x 277	530	250F

Retrouvez toutes les caractéristiques techniques page 60
Find all technical features page 60

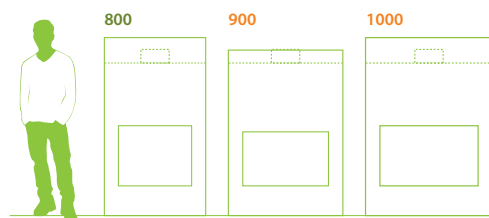



épi 

	dimensions hors tout : hauteur x largeur x profondeur overall dimensions in mm: width x height x depth	âtre : largeur x profondeur hearth: width x depth	hauteur de vision de feu Fire viewing height	Ø sortie de fumées Ø Smoke vent
épi 900 technika	1611 x 682 x 995	428 x 663	551	250

Retrouvez toutes les caractéristiques techniques page 60
Find all technical features page 60

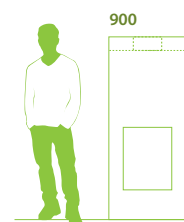



4 faces suspendu



	dimensions hors tout : hauteur x largeur x profondeur overall dimensions in mm: width x height x depth	âtre : largeur x profondeur hearth: width x depth	hauteur de vision de feu Fire viewing height	Ø sortie de fumées Ø Smoke vent
4 faces suspendu 700 technika	1765 x 715 x 781	575 x 575	545	250
4 faces suspendu 800 technika	1765 x 825 x 891	685 x 685	545	250

Retrouvez toutes les caractéristiques techniques page 60
Find all technical features page 60

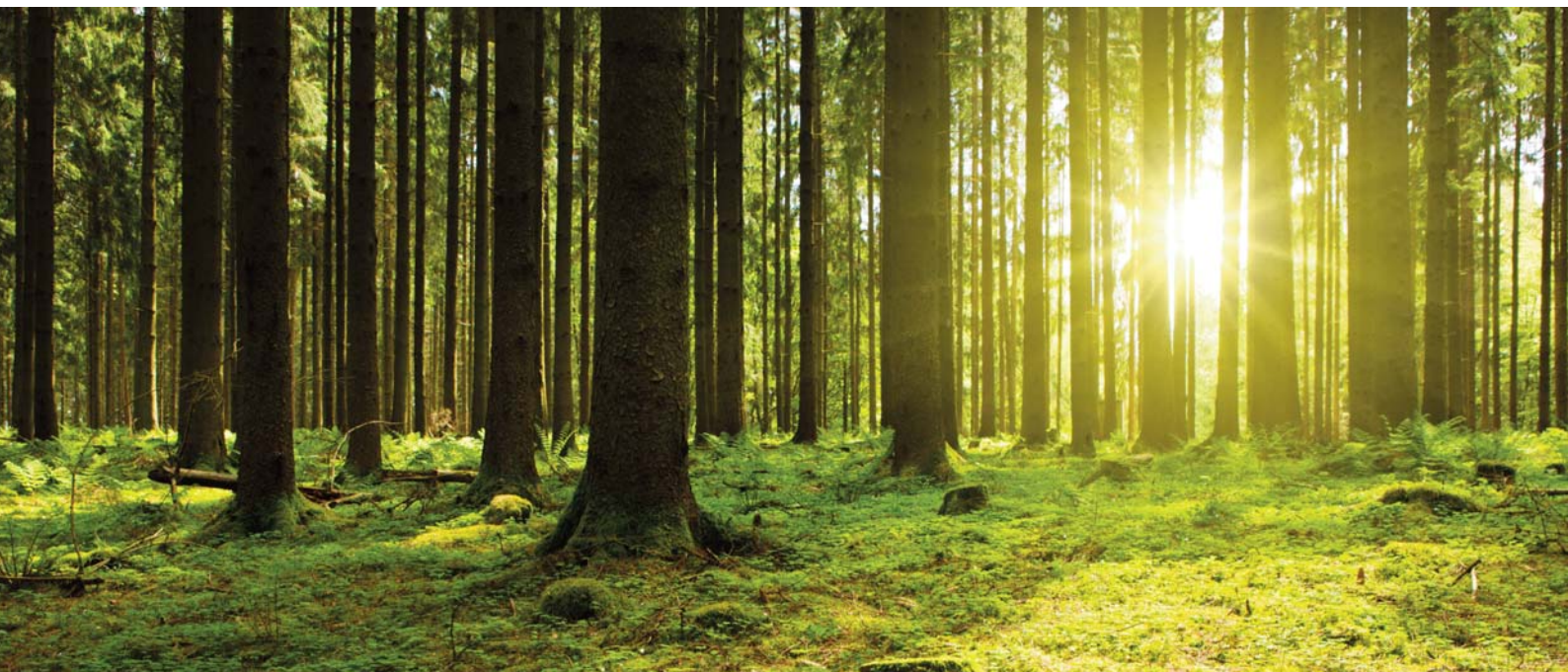
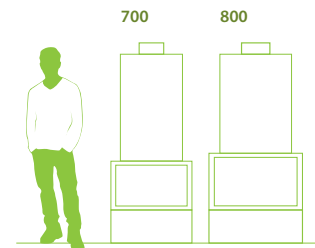



gamme classic

Les foyers Totem de la gamme **classic** sont disponibles en **2 versions** : standard ou boîte à fumée.

1- La version **standard, la plus aboutie** de nos foyers, propose un équipement complet comprenant :

- le carénage enveloppant le foyer qui optimise la récupération de chaleur grâce à ses 4 bouches de distribution d'air chaud ;
- la boîte à fumée qui offre une protection contre les éventuels refoulements à l'ouverture de la porte.

2- La version **boîte à fumée**, perd le carénage enveloppant et ses 4 bouches de distribution d'air chaud. Le reste de l'équipement est le même qu'en standard.

Les foyers Totem **classic** sont idéals **pour la rénovation** de votre maison. Chaque foyer est fabriqué avec le même **niveau d'exigence et de qualité** (choix des aciers, montage, briquetage, peinture de finition, etc...), ce qui vous garantit un appareil **fiable, efficace et performant** pour la rénovation.

1- Standard



2- Boîte à fumée



The TOTEM CLASSIC range fireplaces are available in **2 versions**: standard or smoke trap

1- The **standard** version, **the most completed** integrates the following elements:

- the cover all around the fireplace with 4 hot air vents
- the smoke trap so as to prevent from smoke backflow while opening the doors of the fireplace

2- The **smoke trap** version has no cover, no 4 hot air vents but remains with the smoke trap equipment.

The TOTEM CLASSIC range fireplaces are perfect for buildings or houses to be **renovated**. Each fireplace is made with the **same level of requirement and quality** (selection of the steel, the assembly, the bricks, the finishing paint, etc...) to ensure and provide a **reliable appliance, efficient and effective** for the refurbishment.





vivre autour
du feu
*Live around
fire*

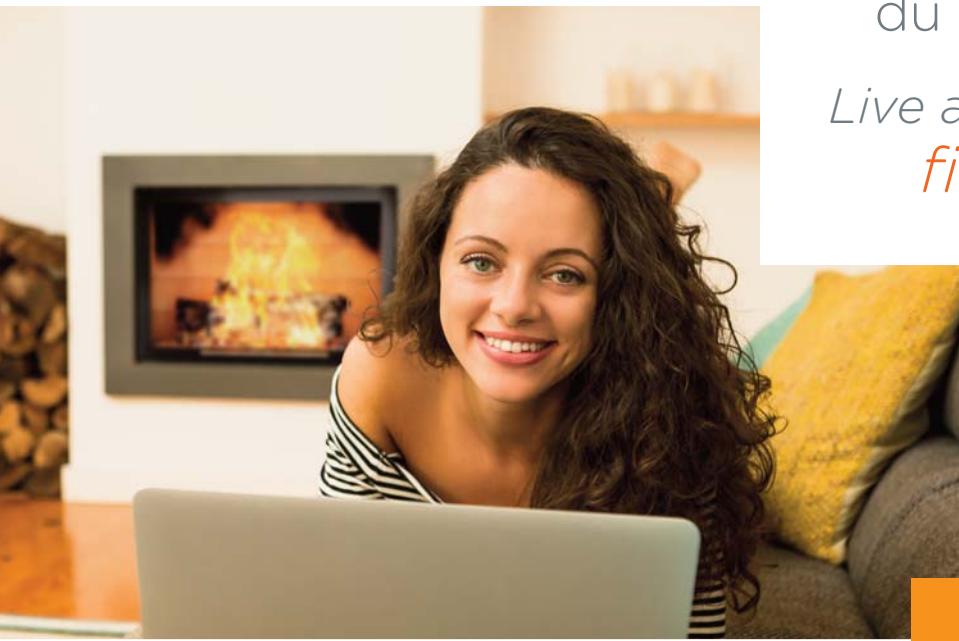

FOYERS

DROITS

g a m m e c l a s s i c

STRAIGHT

FIREPLACES



foyers droits | *straight fireplaces*

frontal



	dimensions hors tout : hauteur x largeur x profondeur overall dimensions in mm: width x height x depth	âtre : largeur x profondeur hearth: width x depth	hauteur de vision de feu Fire viewing height	Ø sortie de fumées Ø Smoke vent
frontal 800	1405 x 842 x 581	650 x 367	474	200
frontal 900	1598 x 942 x 628	750 x 414	570	200
frontal 901	1598 x 942 x 554	750 x 340	570	200
frontal 901 RT	1574 x 971 x 532	750 x 337	570	200F
frontal 1000	1668 x 1082 x 678	890 x 464	605	250
frontal 1100	1780 x 1182 x 686	990 x 472	650	250
frontal 1300	1985 x 1302 x 778	1110 x 564	765	300

Retrouvez toutes les caractéristiques techniques page 60
Find all technical features page 60

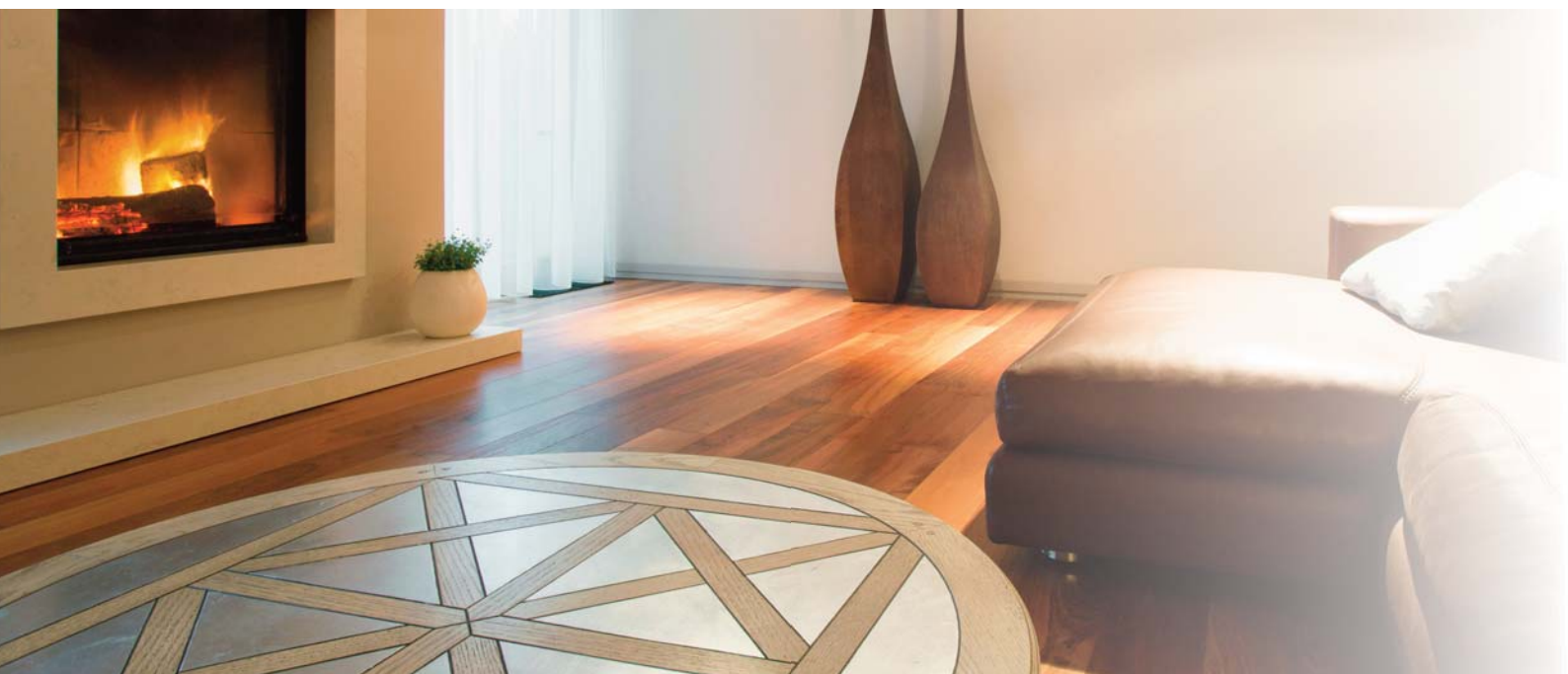
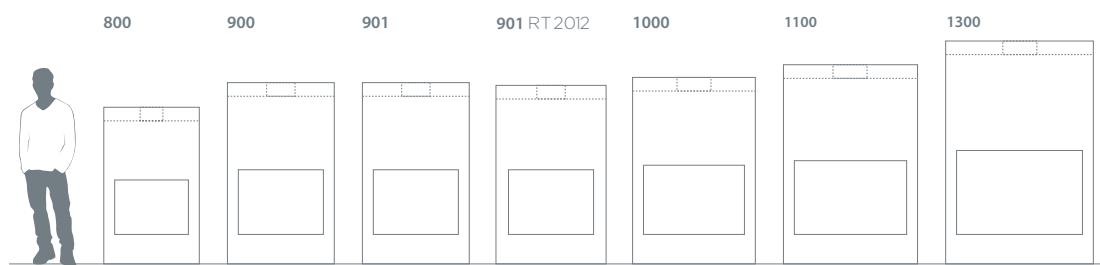



horizon



	dimensions hors tout : hauteur x largeur x profondeur overall dimensions in mm: width x height x depth	âtre : largeur x profondeur hearth: width x depth	hauteur de vision de feu Fire viewing height	Ø sortie de fumées Ø Smoke vent
horizon 901	1265 x 943 x 555	750 x 340	405	200
horizon 901 RT	1245 x 971 x 532	750 x 337	405	180F
horizon 1000 fond droit ou fond conique	1265 x 1088 x 610	896 x 390	405	200
horizon 1100	1478 x 1202 x 610	1010 x 390	510	250
horizon 1300	1478 x 1312 x 610	1120 x 390	510	250
horizon 1400	1478 x 1422 x 610	1230 x 390	510	250

Retrouvez toutes les caractéristiques techniques page 60
Find all technical features page 60

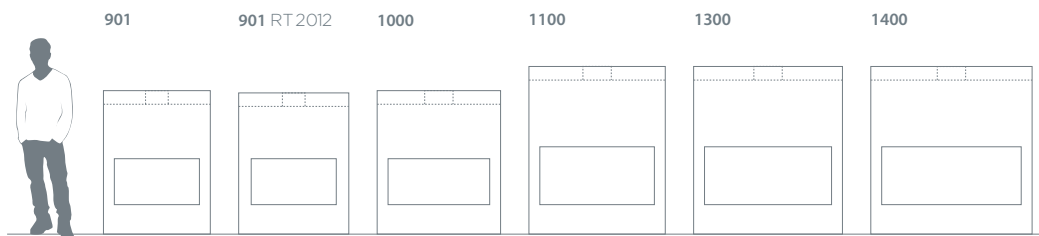



vertivision



	dimensions hors tout : hauteur x largeur x profondeur overall dimensions in mm: width x height x depth	âtre : largeur x profondeur hearth: width x depth	hauteur de vision de feu Fire viewing height	Ø sortie de fumées Ø Smoke vent
vertivision 900	1884 x 790 x 659	598 x 445	994	250

Retrouvez toutes les caractéristiques techniques page 60
Find all technical features page 60

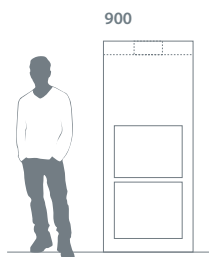





FOYERS

MULTI-

FACES

g a m m e c l a s s i c

MULTISIDED

FIREPLACES



latéral

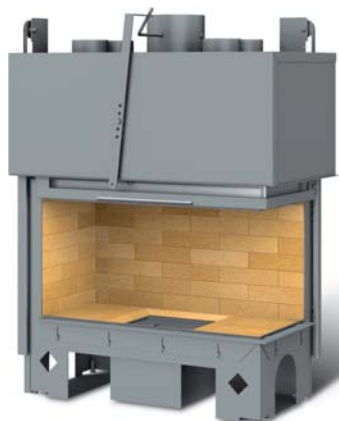

	dimensions hors tout : hauteur x largeur x profondeur overall dimensions in mm: width x height x depth	âtre : largeur x profondeur hearth: width x depth	hauteur de vision de feu Fire viewing height	Ø sortie de fumées Ø Smoke vent
latéral 800	1387 x 903 x 585	700 x 367	465	200
latéral 900	1557 x 973 x 613	770 x 390	564	250
latéral horizon 901	1269 x 1005 x 563	800 x 340	407	200
latéral horizon 1000	1445 x 1076 x 650	890 x 464	490	300

Retrouvez toutes les caractéristiques techniques page 60
Find all technical features page 60

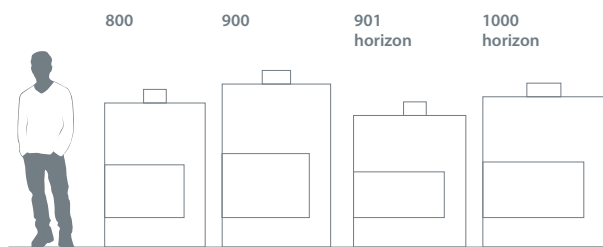



3 faces



	dimensions hors tout : hauteur x largeur x profondeur overall dimensions in mm: width x height x depth	âtre : largeur x profondeur hearth: width x depth	hauteur de vision de feu Fire viewing height	Ø sortie de fumées Ø Smoke vent
3 faces 800	1368 x 974 x 618	750 x 367	450	200
3 faces 900	1583 x 962 x 661	738 x 410	535	250
3 faces horizon 901	1349 x 1074 x 591	850 x 340	443	250
3 faces horizon 1000	1493 x 1164 x 715	940 x 464	490	300

Retrouvez toutes les caractéristiques techniques page 60
Find all technical features page 60

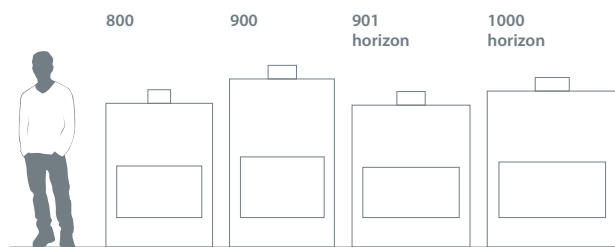





FOYERS

GALBÉS

g a m m e c l a s s i c

CURVED

FIREPLACES



panoramique



	dimensions hors tout : hauteur x largeur x profondeur overall dimensions in mm: width x height x depth	âtre : largeur x profondeur hearth: width x depth	hauteur de vision de feu Fire viewing height	Ø sortie de fumées Ø Smoke vent
panoramique 900	1567 x 936 x 723	700 x 530	545	250

Retrouvez toutes les caractéristiques techniques page 62
Find all technical features page 62

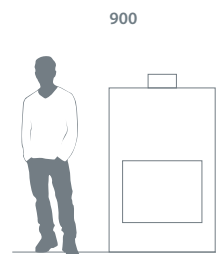



galbé latéral



	dimensions hors tout : hauteur x largeur x profondeur overall dimensions in mm: width x height x depth	âtre : largeur x profondeur hearth: width x depth	hauteur de vision de feu Fire viewing height	Ø sortie de fumées Ø Smoke vent
galbé latéral 900	1358 x 886 x 553	700 x 367	460	200

Retrouvez toutes les caractéristiques techniques page 62
Find all technical features page 62

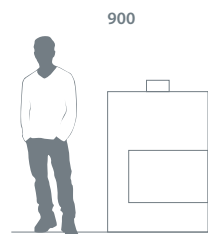





F O Y E R S

RECTO VERSO

SÉPARATIFS

g a m m e c l a s s i c

SEPARATING

DOUBLE SIDED

F I R E P L A C E S



R° frontal V° battant



	dimensions hors tout : hauteur x largeur x profondeur overall dimensions in mm: width x height x depth	âtre : largeur x profondeur hearth: width x depth	hauteur de vision de feu Fire viewing height	Ø sortie de fumées Ø Smoke vent
R° frontal 900 - V° battant	1589 x 968 x 712	750 x 517	570	250
R° frontal 1000 - V° battant	1668 x 1108 x 762	890 x 567	605	300

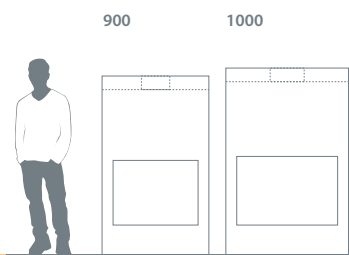

R° horizon V° battant



	dimensions hors tout : hauteur x largeur x profondeur overall dimensions in mm: width x height x depth	âtre : largeur x profondeur hearth: width x depth	hauteur de vision de feu Fire viewing height	Ø sortie de fumées Ø Smoke vent
R° horizon 1000 - V° battant	1265 x 968 x 588	750 x 390	405	200
R° horizon 1100 - V° battant	1265 x 1133 x 644	896 x 440	405	200
R° vertivision 900 - V° battant	1478 x 1228 x 644	1010 x 440	510	250

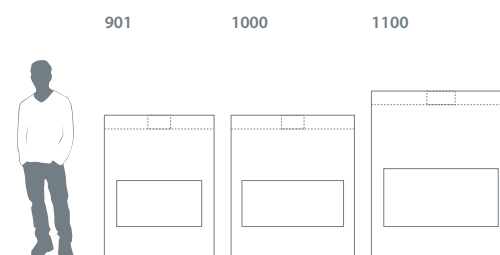



R° vertivision V° battant



	dimensions hors tout : hauteur x largeur x profondeur overall dimensions in mm: width x height x depth	âtre : largeur x profondeur hearth: width x depth	hauteur de vision de feu Fire viewing height	Ø sortie de fumées Ø Smoke vent
R° vertivision 900 - V° battant	1884 x 816 x 707	598 x 512	994	250

Retrouvez toutes les caractéristiques techniques page 62
Find all technical features page 62

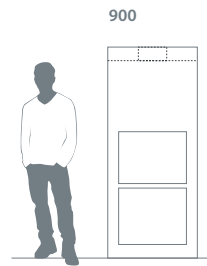

FOYERS

RECTO VERSO

CENTRAUX

g a m m e c l a s s i c

CENTRAL

DOUBLE SIDED

FIREPLACES

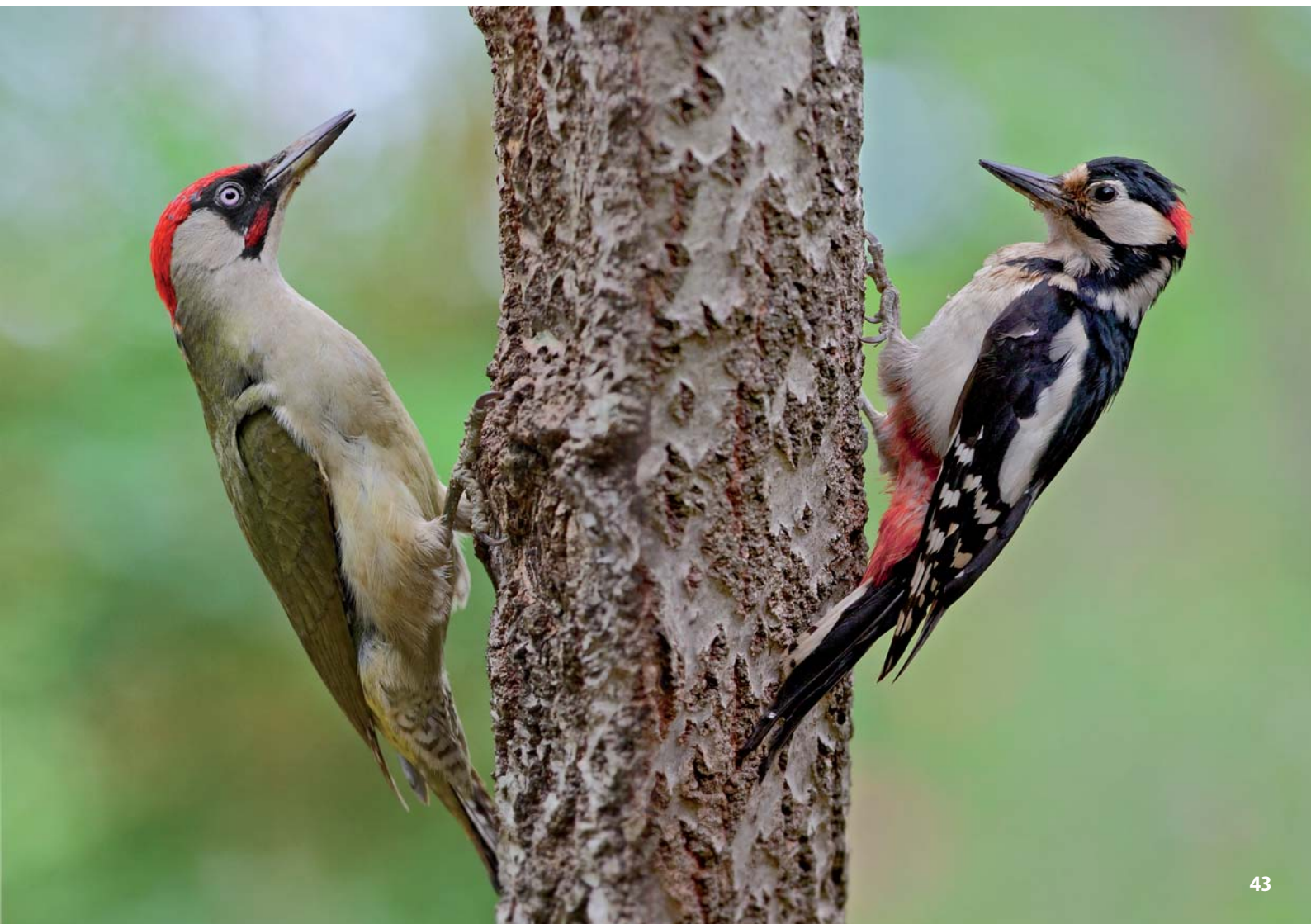

R° V° frontal



	dimensions hors tout : hauteur x largeur x profondeur overall dimensions in mm: width x height x depth	âtre : largeur x profondeur hearth: width x depth	hauteur de vision de feu Fire viewing height	Ø sortie de fumées Ø Smoke vent
R° - V° frontal 900	1598 x 942 x 748	750 x 517	570	250
R° - V° frontal 1000	1668 x 1082 x 798	890 x 567	605	300

Retrouvez toutes les caractéristiques techniques page 62
Find all technical features page 62

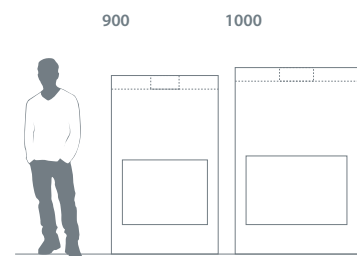





F O Y E R S

SUSPENDUS

g a m m e c l a s s i c

SUSPENDED

F I R E P L A C E S



4 faces suspendu



	dimensions hors tout : hauteur x largeur x profondeur overall dimensions in mm: width x height x depth	âtre : largeur x profondeur hearth: width x depth	hauteur de vision de feu Fire viewing height	Ø sortie de fumées Ø Smoke vent
4 faces suspendu 700 avec sole foyère / with hearth floor	1831 x 770 x 743	606 x 606	550	250
4 faces suspendu 800 avec sole foyère / with hearth floor	1920 x 843 x 870	706 x 706	590	250

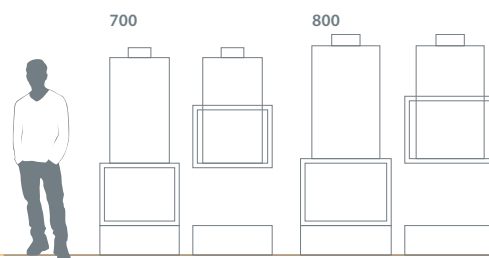

Panoramique suspendu



	dimensions hors tout : hauteur x largeur x profondeur overall dimensions in mm: width x height x depth	âtre : largeur x profondeur hearth: width x depth	hauteur de vision de feu Fire viewing height	Ø sortie de fumées Ø Smoke vent
panoramique 900 suspendu avec sole foyère / with hearth floor	1831 x 770 x 743	606 x 606	550	250

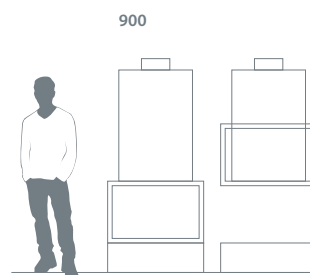





ACCESSOIRES ACCESSORIES



systeme de suspension

simple, pratique et efficace,
l'outil indispensable pour la pose des foyers suspendus.

suspension system

easy, useful, and efficient,
The essential tool to install the hanging fireplaces.

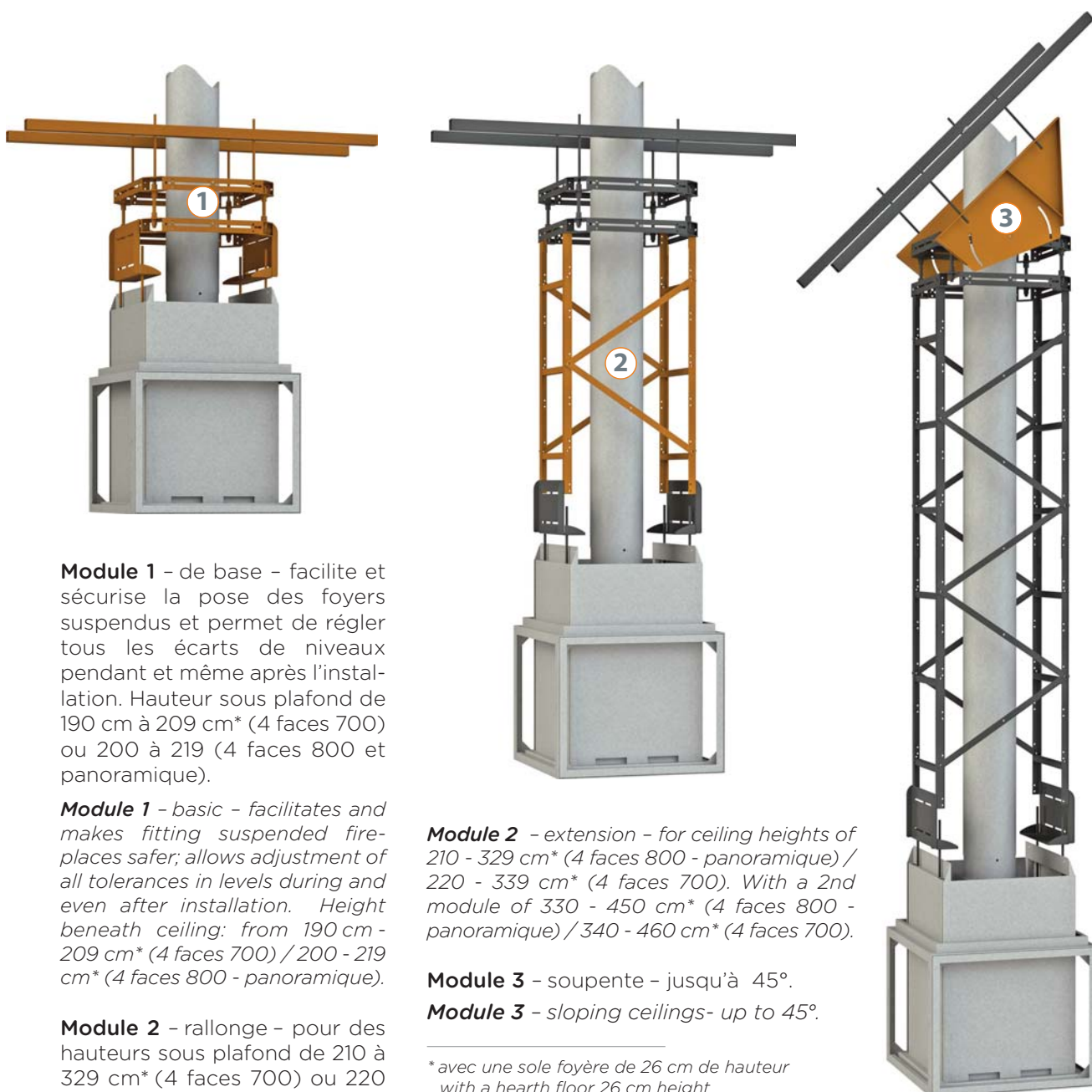

Module 1 - de base - facilite et sécurise la pose des foyers suspendus et permet de régler tous les écarts de niveaux pendant et même après l'installation. Hauteur sous plafond de 190 cm à 209 cm* (4 faces 700) ou 200 à 219 (4 faces 800 et panoramique).

Module 1 - basic - facilitates and makes fitting suspended fireplaces safer; allows adjustment of all tolerances in levels during and even after installation. Height beneath ceiling: from 190 cm - 209 cm* (4 faces 700) / 200 - 219 cm* (4 faces 800 - panoramique).

Module 2 - rallonge - pour des hauteurs sous plafond de 210 à 329 cm* (4 faces 700) ou 220 à 339 cm* (4 faces 800 et panoramique) et de 330 à 450 cm* (4 faces 700) ou 340 à 460 cm* (4 faces 800 et panoramique) avec un deuxième module 2.

Module 2 - extension - for ceiling heights of 210 - 329 cm* (4 faces 800 - panoramique) / 220 - 339 cm* (4 faces 700). With a 2nd module of 330 - 450 cm* (4 faces 800 - panoramique) / 340 - 460 cm* (4 faces 700).

Module 3 - soupente - jusqu'à 45°.

Module 3 - sloping ceilings - up to 45°.

* avec une sole focère de 26 cm de hauteur
with a hearth floor 26 cm height

En option, le nouveau cadre linea pour foyer suspendu vous permet d'assurer la finition et le soutien de la hotte.

As an option, the new Linea frame for suspended fireplaces allows you to ensure the finishing and the support of the hood.



les cadres | frames

classik

Acier 20/10^e plié puis soudé
finition peinture haute température
20/10^e folded and welded steel
High temperature paint finish

Disponibles en 2 coloris
Available in 2 colours



classik
50



zen

Acier 20/10^e plié puis soudé
finition peinture haute température
20/10^e folded and welded steel
High temperature paint finish

Disponibles en 2 coloris
Available in 2 colours



zen 50



zen 25



Les cadres classik et zen peuvent équiper tous nos foyers droits.

Classik and Zen frames are available for all our straight fireplaces and all our double sided fireplaces.



les cadres | frames

optima

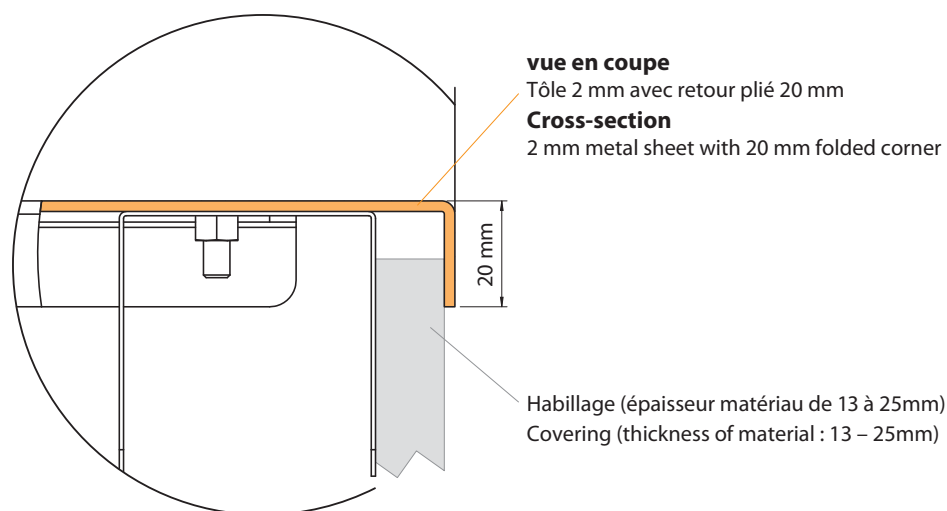

linea

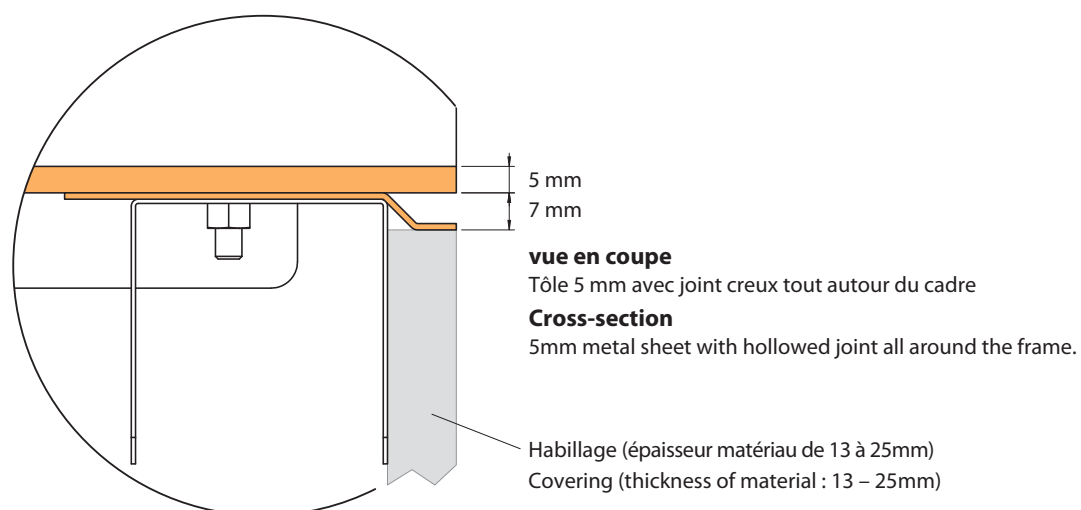

Disponibles en 2 coloris
Available in 2 colours



Les cadres optima et linea peuvent équiper tous nos foyers multifaces.
Optima and linea frames are available for all our multi sided fireplaces.



Porte-bûche | *Log stands*

Fidèles à nos valeurs de sécurité et de simplicité nous avons conçu nos porte-bûches dans un style épuré et résolument actuel. Ils apportent plus de sûreté lors de l'utilisation du foyer porte relevée.

Ils sont découpés dans des tôles d'acier spécial qui sont pliées et soudées avant de recevoir une finition de peinture haute température.

Faithful to our safety and simplicity values, our log stands have a very light and modern design. They provide more safety while using the fireplace with a door open.

They are made with special metal sheets, then folded and welded before being finished with high temperature paint.



porte bûche 600
h x L x l = 7 x 60 x 29
Log stands 600
H x L x W = 7 x 60 x 29

porte bûche 400
h x L x l = 7 x 40 x 29
Log stands 400
H x L x W = 7 x 40 x 29

porte bûche 100
h x L x l = 7 x 10 x 29
Log stands 100
H x L x W = 7 x 10 x 29

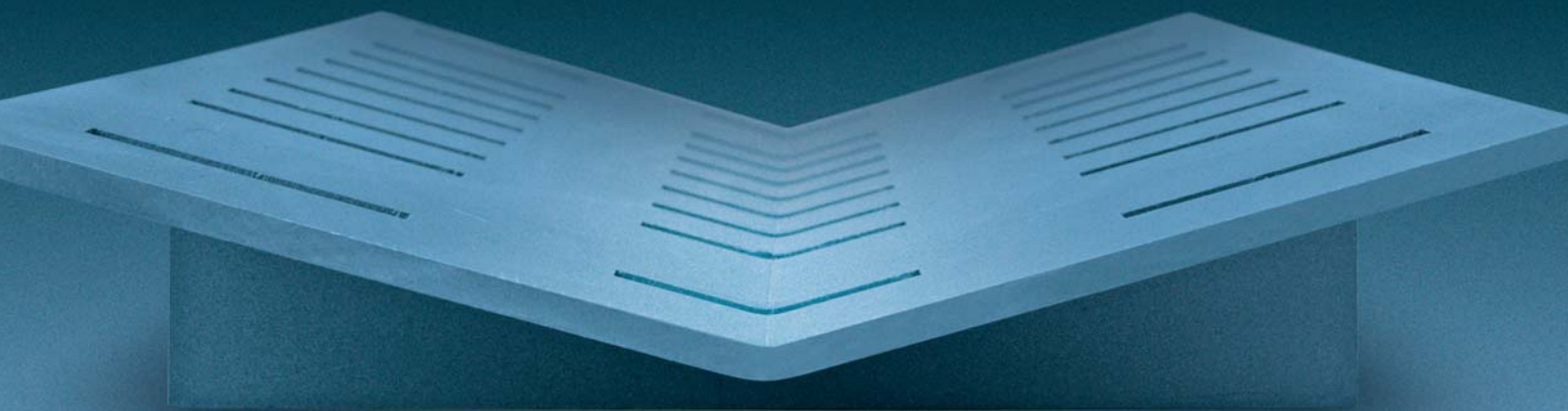

systeme d'accrochage mural | wall hanging system

Dernière **innovation** du bureau d'étude Totem, ce système d'accroche murale offre une toute **nouvelle possibilité d'intégration** des foyers **3 faces** de la gamme **Classic**.
Le foyer se retrouve suspendu au-dessus du sol ce qui ajoute un véritable effet de "**lévitation**" au feu.
Une **nouvelle expérience** de vision intégrale du feu !

*The wall mounting system is the last **innovation** of TOTEM FIRE's study department. It is a **new concept in fitting 3 FACES** fireplaces of the TOTEM **classic** range. The fireplace is fitted above the ground and provides to the fire a "**levitation**" appearance
A **new experience** of total view of fire !*

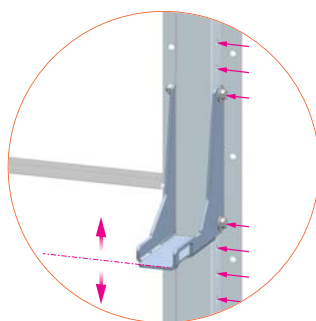
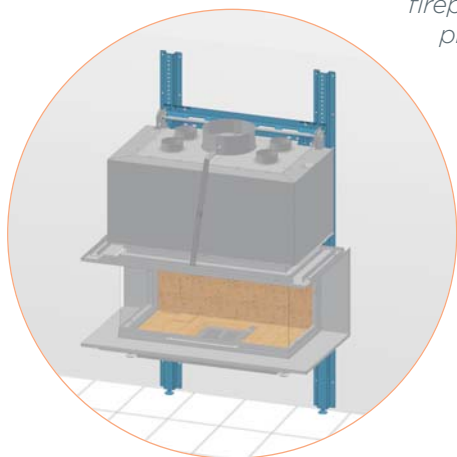













synoptique de la gamme totem

● Equipement de base
By default

○ En option / Option

NB : gamme "classic" disponible en noir ou gris, gamme "technika" uniquement en noir.

NB: "classic" range available in black or grey, "technika" range in black only.

	dimensions en cm / dimensions in cm					poids en kg Weight in kg	performances / Performance				
	dimensions hors tout : hauteur x largeur x profondeur Overall dimensions: Height x width x depth	âtre : largeur x profondeur hearth: width x depth	hauteur de vision de feu Fire viewing height	Ø sortie de fumées Ø Smoke vent	rendement en % Yield in %		puissance annoncée en kW Stated power in kW	Taux de CO en % Rate of CO in %	taux poussière en mg/nm ³ Rate of dust in mg/nm ³	Classe d'efficacité énergétique Energy Efficiency Class	
foyers droits straight fireplaces											
frontal											
frontal 800	1405 x 842 x 581	650 x 367	474	200	260	73	9 → 13,5	0,14	28,00	A	
frontal 800 technika 	1635 x 1008 x 488	704 x 296	505	180F	270	77	8 → 12	0,044	19,80	A	
frontal 900	1598 x 942 x 628	750 x 414	570	200	360	75	9,5 → 14	0,11	27,00	A	
frontal 900 technika 	1745 x 1118 x 488	814 x 296	560	200F		Disponible juin 2019 / Available June 2019					
frontal 901	1598 x 942 x 554	750 x 340	570	200	320	71,4	11,5 → 17,3	0,12	56,40	A	
frontal 901 RT	1574 x 971 x 532	750 x 337	570	200F	320	81,6	8 → 12	0,08	27,70	A	
frontal 1000	1668 x 1082 x 678	890 x 464	605	250	430	71	13,5 → 20	0,06	51,00	A	
frontal 1000 technika 	1745 x 1228 x 488	924 x 296	560	200F		Disponible juin 2019 / Available June 2019					
frontal 1100	1780 x 1182 x 686	990 x 472	650	250	520	73	12 → 18	0,23		A	
frontal 1300	1985 x 1302 x 778	1110 x 564	765	300	630	73	12 → 18	0,23		A	
horizon											
horizon 800 technika 	1525 x 1008 x 488	704 x 296	450	180F	255	77	7 → 10	0,044	19,80	A	
horizon 900 technika 	1635 x 1118 x 488	814 x 296	505	200F		Disponible juin 2019 / Available June 2019					
horizon 901	1265 x 943 x 555	750 x 340	405	200	300	71,4	11,5 → 17,3	0,12	56,40	A	
horizon 901 RT	1245 x 971 x 532	750 x 337	405	180F	300	81,6	7 → 9	0,08	27,70	A	
horizon 1000 fond droit ou fond conique	1265 x 1088 x 610	896 x 390	405	200	350	71	13,5 → 20	0,06	51,00	A	
horizon 1000 technika 	1635 x 1228 x 488	924 x 296	505	200F		Disponible juin 2019 / Available June 2019					
horizon 1100	1478 x 1202 x 610	1010 x 390	510	250	450	78	11,5 → 17	0,23	75,00	A	
horizon 1300	1478 x 1312 x 610	1120 x 390	510	250	480	78	11,5 → 17	0,23	75,00	A	
horizon 1400	1478 x 1422 x 610	1230 x 390	510	250	510	73	12 → 18	0,23		A	
vertivision											
vertivision 900	1884 x 790 x 659	598 x 445	994	250	410	73	8 → 12	0,20	34,30	A	
foyers multifaces multisided fireplaces											
latéral											
latéral 800	1387 x 903 x 585	700 x 367	465	200	250	73	9 → 13,5	0,14	28,00	A	
latéral 800 technika 	1569 x 900 x 676	607 x 347	530	200F	290	80	9 → 13	0,042	12,00	A	
latéral 900	1557 x 973 x 613	770 x 390	564	250	330	75	9,5 → 14	0,11	27,00	A	
latéral 900 technika 	1462 x 1010 x 606	712 x 277	475	200F	315	78	9 → 13,5	0,065	15,50	A	
latéral horizon 901	1269 x 1005 x 563	800 x 340	407	200	300	71,4	11,5 → 17,3	0,12	56,40	A	
latéral horizon 1000	1445 x 1076 x 650	890 x 464	490	300	380	78	11,5 → 17	0,23	75,00	A	
latéral hor. 1000 technika 	1569 x 1120 x 607	827 x 277	530	200F	340	78	9,5 → 14	0,065	15,50	A	
3 faces											
3 faces 800	1368 x 974 x 618	750 x 367	450	200	265	73	9 → 13,5	0,14	28,00	A	
3 faces 800 technika 	1569 x 900 x 676	646 x 347	530	250F	280	80	9 → 13	0,042	12,00	A	
3 faces 900	1583 x 962 x 661	738 x 410	535	250	295	75	9,5 → 14	0,11	27,00	A	
3 faces 900 technika 	1459 x 1010 x 606	756 x 277	476	250F	270	78	9 → 13,5	0,065	15,50	A	
3 faces horizon 901	1349 x 1074 x 591	850 x 340	443	250	310	71,4	9,5 → 14	0,12	56,00	A	
3 faces horizon 1000	1493 x 1164 x 715	940 x 464	490	300	380	78,0	11,5 → 17	0,23	75,00	A	
3 faces hor. 1000 technika 	1569 x 1120 x 606	866 x 277	530	250F	320	78	9,5 → 14	0,065	15,50	A	
épi 900 technika 	1611 x 682 x 995	428 x 663	551	250	300	80	9 → 13	0,042	12,00	A	

synoptique de la gamme totem

● Equipement de base
By default

○ En option / Option

NB : gamme "classic" disponible en noir ou gris, gamme "technika" uniquement en noir.

NB: "classic" range available in black or grey, "technika" range in black only.

	dimensions en cm / dimensions in cm				Ø sortie de fumées Ø Smoke vent	poids en kg Weight in kg	rendement en % Yield in %	performances / Performance			
	dimensions hors tout : hauteur x largeur x profondeur buitenafmetingen: hoogte x breedte x diepte	âtre : largeur x profondeur hearth: width x depth	hauteur de vision de feu Fire viewing height					puissance annoncée en kW Stated power in kW	Taux de CO en % Rate of CO in %	taux poussière en mg/nm ³ Rate of dust in mg/nm ³	Classe d'efficacité énergétique Energy Efficiency Class
foyers galbés curved fireplaces											
panoramique 900	1567 x 936 x 723	700 x 530	545	250	330	75	9,5 → 14	0,11	27,00	A	
galbé latéral 900	1358 x 886 x 553	700 x 367	460	200	320	75	9,5 → 14	0,11	27,00	A	

foyers recto-verso séparatifs separating double sided fireplaces											
R° frontal 900 - V° battant	1589 x 968 x 712	750 x 517	570	250	375	75	9,5 → 14	0,11	27,00	A	
R° frontal 1000 - V° battant	1668 x 1108 x 762	890 x 567	605	300	425	71	13,5 → 20	0,06	51,00	A	
R° horizon 901 - V° battant	1265 x 968 x 588	750 x 390	405	200	250	71,4	11,5 → 17,3	0,12	56,40	A	
R° horizon 1000 - V° battant	1265 x 1133 x 644	896 x 440	405	200	300	71	13,5 → 20	0,06	51,00	A	
R° horizon 1100 - V° battant	1478 x 1228 x 644	1010 x 440	510	250	450	78	11,5 → 17	0,23	75	A	
R° vertivision 900 - V° battant	1884 x 816 x 707	598 x 512	994	250	410	74	8 → 12	0,20	34,30	A	

foyers recto-verso centraux central double sided fireplaces											
R° - V° frontal 900	1598 x 942 x 748	750 x 517	570	250	395	75	9,5 → 14	0,11	27,00	A	
R° - V° frontal 1000	1668 x 1082 x 798	890 x 567	605	300	445	71	13,5 → 20	0,06	51,00	A	

foyers suspendus avec sole foyer suspended fireplaces with hearth floor											
4 faces suspendu 700	1831 x 770 x 743	606 x 606	550	250	370	78	13,5 → 20	0,19		A	
4 faces suspendu 700 technika	1765 x 715 x 781	575 x 575	545	250	260	79%	11,5 → 16,9	0,18%	80	A	
4 faces suspendu 800	1920 x 843 x 870	706 x 706	590	250	390	78	13,5 → 20	0,19		A	
4 faces suspendu 800 technika	1765 x 825 x 891	685 x 685	545	250	310	79%	11,5 → 16,9	0,18%	80	A	
panoramique 900 suspendu	1885 x 847 x 847	Ø 750	545	250	360	78	13,5 → 20	0,19		A	

synoptic of the totem range

poignée / Handles				briques / bricks						options								
acier brossé ou noir Brushed steel or Black steel		acier brossé Brushed steel		5.5 x 22 claires sans joints 5.5 x 22 yellow without seam		5.5 x 22 claires avec joints 5.5 x 22 yellow with seam		5.5 x 22 noires sans joints 5.5 x 22 black without seam		11 x 22 claires sans joints 11 x 22 yellow without seam		11 x 22 claires avec joints 11 x 22 yellow with seam		11 x 22 noires sans joints 11 x 22 black without seam		boîte à fumée smoke box	socle surbaissé 12 cm lowered base 12 cm	fer de soutien de hotte hood support iron
galbée 120 mm curved 120 mm																		
	●			●	●		○								○			○
	●	●		●	●		○								○	○		○
droite 120 mm straight 120 mm																		
droite 350 mm straight 350 mm																		
droite 445 mm straight 445 mm																		



	●																	
	●																	
			●															
			●															
				●														
	●																	



	●																	
	●																	



	●																	
	●																	
	●																	
	●																	
●	●																	



schéma **dynamique** *dynamic drawing*

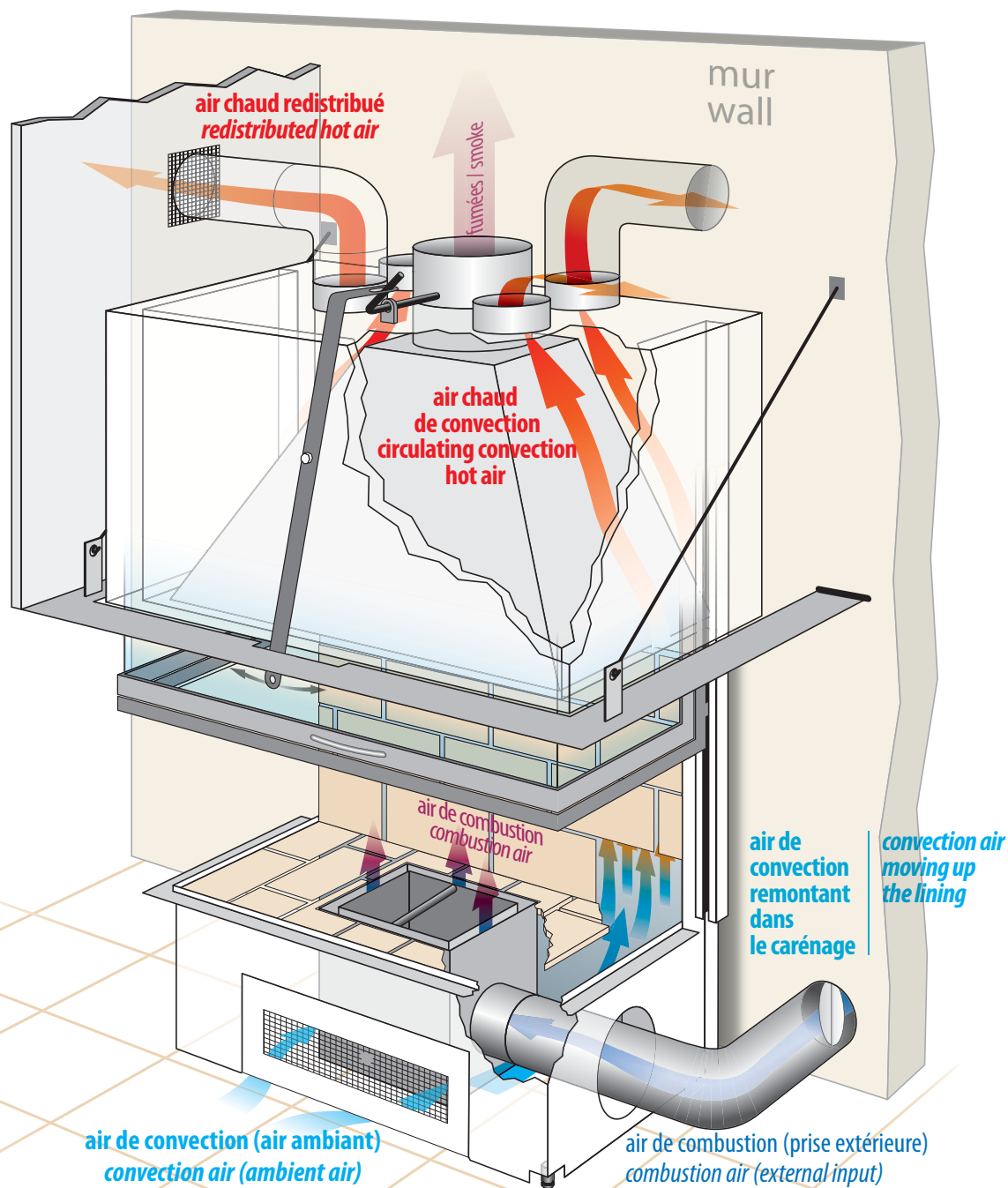



TU TEM

The logo features the letters 'TU TEM' in a bold, dark blue, sans-serif font. The letter 'U' is replaced by a stylized orange flame icon with three distinct upward-pointing tongues. The background is a semi-transparent forest scene with a path leading through trees, overlaid with a pattern of wood cross-sections on the left side.



Les gammes Totem représentent aujourd'hui
50 modèles de foyers et inserts...
 ...nous sommes sûrs que vous y trouverez **le vôtre**.

*the Totem range now includes
 50 models of fireplaces...
 ...we are sure that you'll find yours amongst them.*



TOTEM FIRE SAS
 4, avenue du Guimand
 F-26120 MALISSARD / Valence - Drôme
 tél. (33) 0 4 75 40 18 89
 commercial@totemfire.com



www.totemfire.com

votre revendeur | Your dealer